

Specialty Film & Sheet



Make light work

SABIC Innovative Plastics offers value-added glazing solutions that are founded on a broad portfolio of multiwall sheet products backed by advanced technical support around the world.

From conservatories, commercial greenhouses and swimming pools, to industrial buildings, offices and football stadiums, this versatile range of materials helps to deliver state-of-the-art, lightweight glazing for commercial, industrial and residential applications.

Lexan* Thermoclear* sheet and Lexan sheet systems can be relied upon to deliver high quality, low maintenance glazing that is built to last. Based on Lexan polycarbonate resin, one of the most versatile materials in the world, these high performance materials are characterized by high impact strength, an excellent balance of low weight and high stiffness and naturally “water-clear” transparency. Most of the products are backed by a minimum 10-year limited written warranty against loss of mechanical, optical and thermal properties through weathering. A well-established brand name for over 20 years, Lexan Thermoclear sheet is widely specified by architects and designers around the world who have a common brief - to let the light in and keep the elements out. This unique sheet portfolio is amongst the most extensive on the market today, offering hundreds of possible combinations of structure, color, coating and finish.

Lexan sheet systems provide flexible design solutions for industrial roofing and office facades. Designed for easy, fast assembly, these creative products help to lower system costs whilst enhancing durability, thermal insulation and safety.

Advances in sheet and processing technology keep in step with application requirements and increasingly stringent industry standards. SABIC Technical Centers in China, Japan, Korea, India, the Netherlands and the USA help to keep customers at the leading edge of sheet technology. Furthermore, SABIC Innovative Plastics benefits from global cross-business resources and expertise.



UV protection

Lexan* Thermoclear* Plus sheet has on two sides proprietary UV-protected surface, giving superior resistance to outdoor weathering.

This unique protection help to provide long-term optical quality under intensive UV exposure, and maintains the superior toughness of the polycarbonate material in comparison to other thermoplastic glazing.

According to accelerated 4,000 hours weathering tests (figure 1) (DIN53387 / ASTM G26) that have been carried out at SABIC Innovative Plastics Laboratories, Lexan Thermoclear sheet is superior to other available polycarbonate multiwall glazing products. This test is comparable to 10 years outdoor exposure in moderate climate conditions.

Lexan Thermoclear offers a ten year limited written warranty against discoloration, loss of light transmission and loss of impact strength due to weathering.

The photos presented here show 3 polycarbonate multiwall sheet samples displaying 3 levels of Yellowness Index

- Sample 1: Yellowness Index of 0 Δ
(Reference sample = original value)
- Sample 2: Yellowness Index of 2 Δ
compared to the original value
- Sample 3: Yellowness Index of 10 Δ
compared to the original value

Yellowness Index measurement is performed according to ASTM D1925 (1977) test. The limited written warranty states that Lexan Thermoclear Plus sheets (in a clear color) will not display a change in Yellowness Index of more than 2 Δ (sample 2) compared with their original value (sample 1), whereas most of other PC multiwall sheet producers warrant that their sheets will not display a change in Yellowness Index of more than 10 Δ (sample 3).

Please consult your local distributor or SABIC Innovative Plastics Sales Office for more details.



Sample 1 - $\Delta Y_i = 0$



Sample 2 - $\Delta Y_i = 2$ - Lexan Thermoclear Plus sheet warranty



Sample 3 - $\Delta Y_i = 10$ - Typical Multiwall PC sheet warranty

Figure 1
Yellowness index through weathering

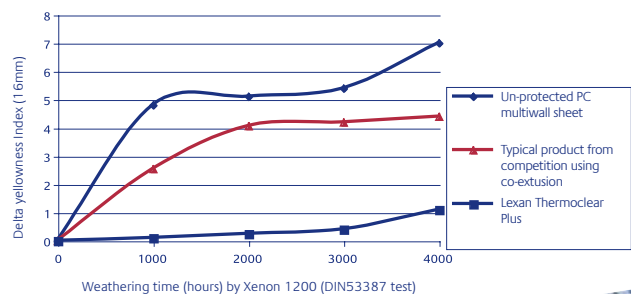

Weathering time (hours) by Xenon 1200 (DIN53387 test)

A striking example of state-of-the-art glazing was seen at the roof glazing of six stadiums that hosted the UEFA Euro 2004™ football tournament in Portugal. For these particular stadiums, more than 74,000m² of double side UV protected Lexan® Thermoclear® sheet has been used for the roof glazing in Portugal.



Corn. Bak BV, a world leading grower and exporter of Bromelia plants, has adopted Lexan ZigZag® polycarbonate panels for the roof refurbishment of three of its greenhouses, a total area of 3,800 m². The special shape of the twin-wall Lexan ZigZag polycarbonate panel reflects light back into the greenhouse thereby generating higher light transmission in the greenhouse than with single glass. Moreover, the double wall retains 45% more heat than single glass, providing a major advantage to growers, as using Lexan ZigZag polycarbonate panels allows greater insulation and higher light transmission. In addition, the hail resistancy and the warranted light transmission over lifetime, makes Lexan ZigZag sheet an excellent candidate for greenhouse glazing.



The newest, one of the largest round roofs (52,000 m²) in the world – that of the massive new Shanghai South Railway Station – is being constructed of clear, tough Lexan polycarbonate (PC) multiwall sheet from SABIC Innovative Plastics. The materials' virtually unmatched impact and ultraviolet resistance, plus its clarity and outstanding dimensional stability, made it the top choice of both the architects and the Chinese authorities involved in the project. Much of the roof of the Shanghai South Railway Station covers the upper departure area of the station, which is around 300 meters in diameter and capable of holding up to 10,000 people.

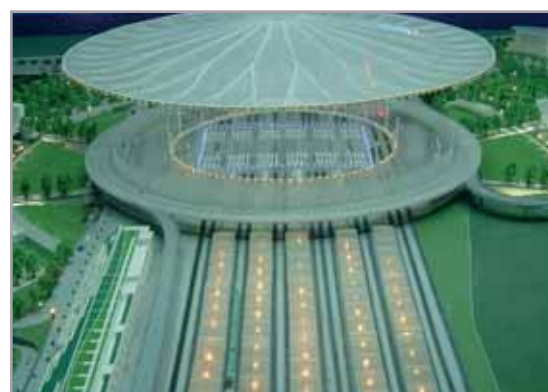

SABIC Innovative Plastics, Specialty Film & Sheet worked together with HOK architectural company on the Sydney Olympic Stadium project, where 27,000m² of 16mm Lexan Thermoclear sheet was used for the most challenging engineering feature of the stadium, the 300-metre span roof structure. Suspended from a huge arch structure, the roof is constructed from a translucent grade of polycarbonate to help minimize any shadows and patches of direct sunlight on the sporting area. Its light, steel and sheet combination structural weight of 85kg/m² (the sheet weight is only 3kg/m²) provides spectators with protection from the weather, whilst reducing the wind resistance for the participants on the field.



Lexan* Thermoclear* sheet, all-around efficiency

- Lightweight – an outstanding balance of low weight and high stiffness enables lightweight structures with greater spans to be designed and easily installed
- Ease of installation – it can be easily cut on site using conventional tools and can be cold-formed into tight radii without pre-forming. Material wastage is minimal as the sheet will not crack or split when cut, sawed or drilled
- Excellent energy efficiency – the multiwall construction traps air between the layers, which ensures outstanding thermal insulation performance
- Low flammability – the high performance Lexan multiwall sheets in this brochure are characterized by both exceptionally good flame resistance, according to Underwriters' Laboratories (UL 94), and excellent heat stability
- UV resistance – the proprietary surface treatment provides almost total resistance to degradation from UV radiation in sunlight, thereby helping to maintain long-term high light transmission
- Comprehensive warranty – most of the Lexan Thermoclear products carry a minimum 10-year limited written warranty against excessive yellowing, loss of light transmission and loss of strength due to weathering
- Broad portfolio – a range of structures, coatings, colors, dimensions and gauges enables glazing performance to be tailored to help meet specific performance criteria
- Environmental standards – in many cases these high performance polycarbonate sheet products may be recycled

Manufactured at six sites worldwide, Lexan Thermoclear sheet is helping customers around the world to develop imaginative glazing with the right balance of thermal insulation and light transmission. Customers can choose between two-, three-, five- and six-wall constructions, in a variety of thicknesses and sizes, to suit a broad range of design requirements. In applications where superior stiffness is required, SABIC Innovative Plastics offers X-structures.

Figure 2
Weight comparison

Thickness		Lexan Thermoclear sheet		Glass	
mm	Inches	kg/m ²	lbs/ft ²	kg/m ²	lbs/ft ²
6	0.236"	1,3	0,27	14,7	3,02
8	0.315"	1,5	0,31	19,7	4,03
10	0.395"	1,7	0,35	24,5	5,03
16	0.629"	2,7	0,55	39,3	8,05

Figure 3
Impact resistance

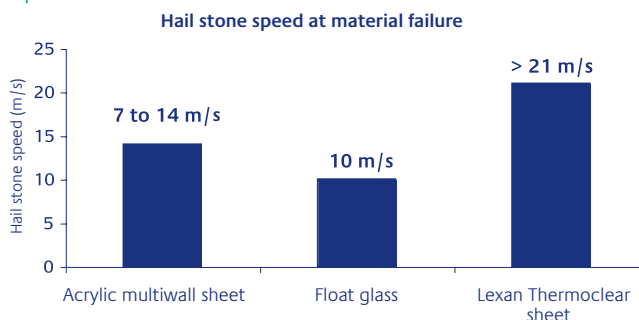

Figure 4
Light transmission through weathering

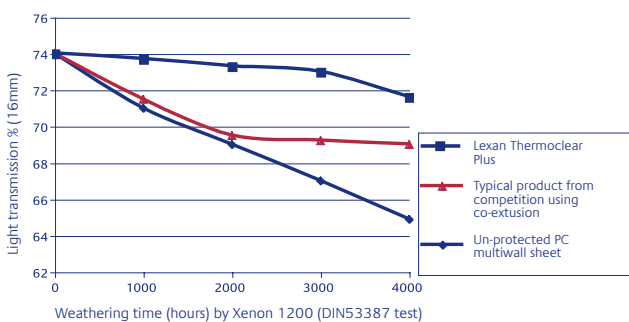
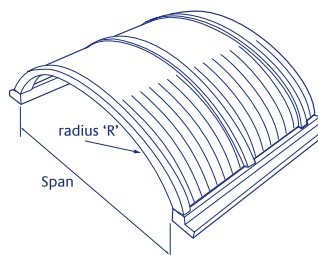

Figure 5
Cold forming

Lexan Thermoclear sheet thickness		Min. cold curving radius 'R'	
6 mm	0.236"	1050 mm	41"
8 mm	0.315"	1400 mm	55"
10 mm	0.395"	1750 mm	69"
16 mm (3 wall)	0.629"	2800 mm	110"
20 mm	0.787"	3500 mm	138"



X-structures for X-tra stiffness

Lexan Thermoclear X-Structure sheet has a unique structure. Instead of the traditional rectangular form, this sheet is made up of diagonal ribs between the vertical ribs. This increases both lateral and longitudinal rigidity, which brings extremely high stiffness to the glazing panel. The X-structure also enhances thermal insulation, sound insulation and impact energy absorption. In practical terms, this means greater hail- and snow-loading resistance and a reduced 'drum' effect.

High quality aesthetics through color

Standard colors of clear, opal white and bronze are available across the Lexan Thermoclear sheet range. Non-standard colors are available in certain gauges. These colors include dark grey, blue, green, dark blue and opaque white.

Broad design freedom through double-sided UV protection

Lexan Thermoclear Plus multiwall sheet is the standard UV-resistant material in the portfolio. UV-protected on both surfaces, it offers wide design flexibility as well as important advantages in both cutting and installation. Unlike with competitive products, installation mistakes are minimized as either sheet surface may be faced outwards.

Figure 6

X structure stiffness versus rectangular structure. Center to center distance (mm) of glazing profiles (a). % of savings (Glazing profiles and installation labor)

Lexan Thermoclear	Loading	1000 N/m ²	1600 N/m ²
10 mm rectangular structure	LT2UV102RS17	620	520
10 mm X structure	LT2UV103X20	850	740
	% of savings	37%	42%
16mm rectangular structure	LT2UV163TS27	880	700
16mm X structure	LT2UV163X29	1130	995
	% of savings	28%	42%
20mm rectangular structure	LT2UV205RS33	1070	860
20mm X structure	LT2UV205X32	1250	1100
	% of savings	17%	28%
25mm rectangular structure	LT2UV256RS35	1250	1150
25mm X structure	LT2UV255X34	1350	1200
	% of savings	8%	4%
32mm X structure	LT2UV325X38	1500	1250

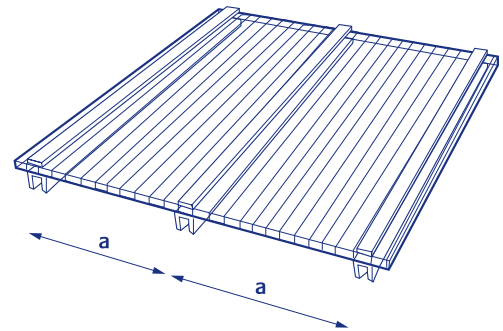

Figure 7

Product selection Lexan Thermoclear sheet

Structures	Nomenclature (Thermoclear-Plus)	Gauge (mm)	Weight (kg/m ²)	Rib distance (mm)	U value (W/m ² ·K)	Light transmission Clear (1+2)	Hobby greenhouses	Industrial greenhouses	Swimming pool covers	Verandas	Rooflight	Stadium roofing	Airport / rail / bus terminal roofing	General large building	Industrial roofing and cladding	Furniture / partition walls	Signs	
Twin Wall	LT2UV42RS800	4	0,8	6	4,1	80%	■										■	■
	LT2UV452RS10	4,5	1,0	6	4,0	80%	■										■	■
	LT2UV62RS13	6	1,3	6	3,5	80%	■		■								■	■
	LT2UV82RS15	8	1,5	10	3,3	78%	■		■								■	
	LT2UV102RS17	10	1,7	10	3,0	77%	■	■	■	■	■						■	
X structure Triple wall	LT2UV103X20	10	2,0	16	2,5	61%						■	■	■	■			
	LT2UV163X29	16	2,9	16	2,3	55%				■		■	■	■	■			
Triple Wall	LT2UV103TS17	10	1,7	10	2,7	70%			■	■	■							
	LT2UV103RS19	10	1,9	19	2,7	76%			■	■	■							
6 Walls	LT2UV163TS27	16	2,7	20	2,4	74%	■	■	■	■	■	■	■	■	■	■		
	LT2UV256RS35	25	3,5	20	1,5	43%				■	■	■	■	■	■	■		
5 walls	LT2UV205RS33	20	3,3	18	1,8	63%				■	■	■	■	■	■			
X structure 5 walls	LT2UV205X32	20	3,2	20	1,8	44%				■	■	■	■	■	■			
	LT2UV255X34	25	3,4	20	1,6	41%				■	■	■	■	■	■			
	LT2UV325X38	32	3,8	20	1,4	38%				■	■	■	■	■	■			

Superior weatherability

Lexan* Thermoclear* SunXP sheet

In addition to the inherent properties of the Lexan Thermoclear range, this range of products offers UV protection on both sides, but with even higher resistance to UV radiation, yellowing and loss of light transmission. This exceptional material is awarded a unique 15 years limited written warranty.

Self-cleaning

Lexan Thermoclear Easy Clean sheet

This is the world's first self-cleaning polycarbonate sheet. UV protected on both sides, Lexan Thermoclear Easy Clean sheet features a unique hydrophobic coating on the outside surface that reduces the surface tension of polycarbonate and increases the contact angle of water to the sheet. This causes larger droplets to form and wash away dirt, leaving the sheet almost spotless. Furthermore, it stays clean for longer, thereby reducing the frequency and the associated cost of cleaning.

Anti-drip

Lexan Thermoclear Dripgard® sheet

Lexan Thermoclear Dripgard sheet is suitable for any roof glazing application in which water droplets are unacceptable, such as commercial greenhouses where they could cause crop spoilage.

This innovative product has UV protection on the outer surface and a specially developed hydrophilic coating on the inner surface. This coating reduces the formation of condensation droplets by increasing the surface tension of the sheet and decreasing the contact angle. As a consequence, a thin mist of water will form on the inner surface of the sheet, which will not drip and will not affect the excellent light transmission of the material.

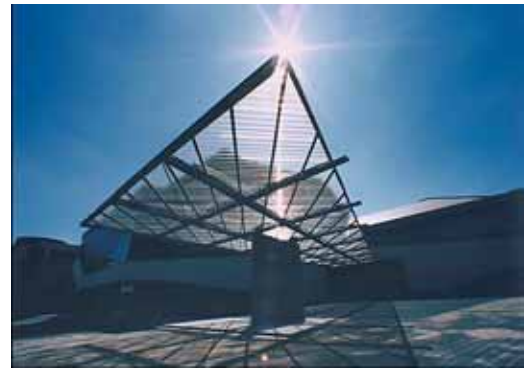

Figure 8

Lexan Thermoclear Easy Clean sheet - hydrophobic

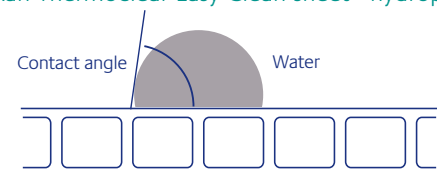
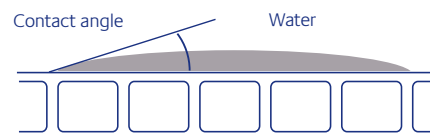

Figure 9

Lexan Thermoclear Dripgard sheet - hydrophilic



Heat management

Lexan® Solar Control IR® multiwall sheet

Lexan Solar Control IR multiwall sheet is transparent with a light green tint, which blocks near infrared heat but lets in high levels of light. Proprietary resin additives are used to manage heat instead of expensive and fragile coatings, which can be damaged during handling and installation. Because the additive technology is inherent to the polymer, solar control properties are permanent and sheets are UV protected on both sides, which can help installers reduce losses due to installation errors.

This innovative solar control-glazing product significantly reduces solar transmission while simultaneously offering high levels of light transmission, helping save energy costs for cooling and lighting buildings. Furthermore, its superior UV resistance and toughness is backed by a 10-year limited written warranty against reduction of light or solar transmission properties, yellowing and breakage due to hail impact.

Lexan Solar Control IR sheet offers outstanding design freedom due to its ability to be cold-formed without losing impact or weathering properties. It is an excellent candidate therefore for a broad range of glazing applications including roof domes, skylights and walkways.

Innovative aesthetics

Lexan Thermoclear® Venetian sheet

Lexan Thermoclear Venetian sheets are UV-protected on the outer surface and screen-printed with white stripes on the inner surface. Although the screen-printed white stripes are mainly intended for decorative purposes, they also provide a shadow effect. This helps to reduce heat build-up from solar radiation, resulting in an improved comfort level inside the building.

Lexan Thermoclear sheet Metallic Look

The addition of fine metallic pigment into the multiwall sheet provides both a completely new look and acts as a heat blocker by reflecting heat. It also cuts down the brightness of the sun to a pleasant level. This material maintains the standard level of mechanical properties.

Lexan Thermoclear sheet Hammered Glass Look

In this unique material, the addition of glass fibers into the sheet provides an original “hammered glass” effect. In addition to the innovative look, it provides UV protection on both sides, high light transmission and good insulation properties. Typical applications include interior partition walls, swimming pool enclosures and bathroom glazing.

Figure 10

Lexan Solar Control IR sheet selectively blocks the near infra-red region of the light, therefore reduces the heat build up

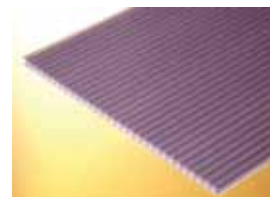
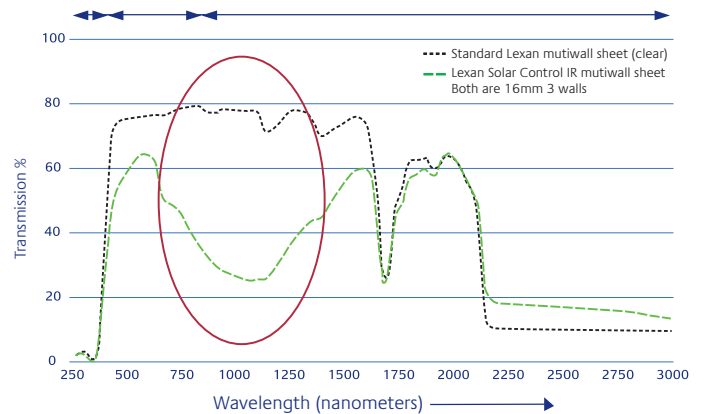

Lexan* sheet systems - low system costs, high performance

The Lexan sheet systems portfolio provide creative glazing solutions for industrial roofing and facades. Characterized by the outstanding optical and mechanical properties of Lexan polycarbonate resin, each product in the portfolio is designed to provide added value performance through potentially low systems costs and consistent high quality. Installation costs may be kept low as each product is designed using custom-made configurations for fast on site assembly. A 10 year limited written warranty is given against loss of light transmission, discoloration and breakage.

Profile-free facades

Lexan Thermoclick* sheet systems

Mainly used in façade applications, Lexan Thermoclick sheet systems are made up of 40mm, UV protected, multiwall sheet panels with a profiled tongue and groove connection. This inter-connecting system eliminates the need for vertical profiles, thereby potentially saving costs and enhancing aesthetics. The x-structure of the sheet provides exceptional stiffness and thermal insulation.

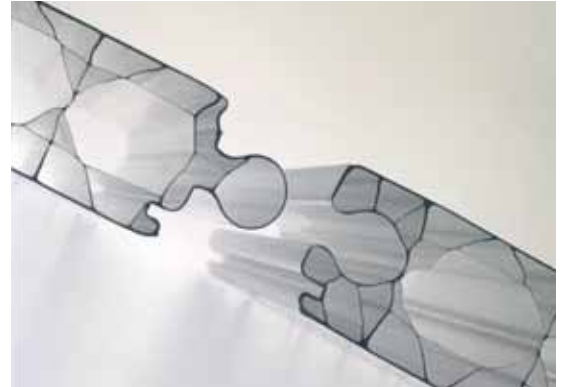

Flexible top-to-gutter designs

Lexan Thermopanel* sheet systems

Typically used in insulated corrugated metal roofing applications, Lexan Thermopanel sheets are 30mm, UV protected multiwall panels with integrated side wings. Customers can select from different side wing profiles that can be easily calibrated to fit onto virtually any metal sandwich panel.

Available in lengths of up to 20 meters, Lexan Thermopanel sheets have a four-wall construction, which provides excellent thermal insulation, high stiffness and high light transmission.

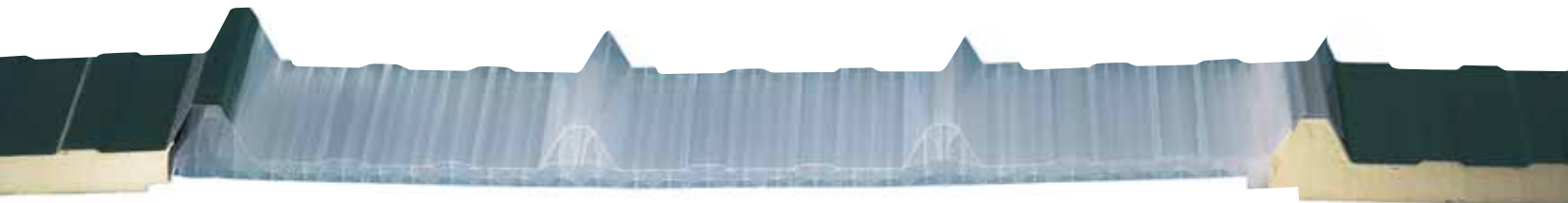
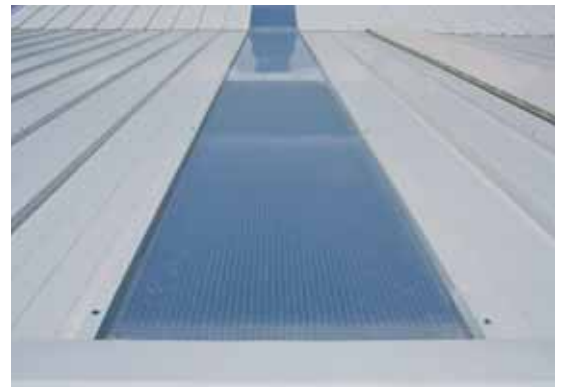

Custom-made industrial rooflights

Lexan Thermoroof* sheet systems

Lexan Thermoroof sheet systems offer a tailor-made, fully insulated rooflight that can be installed seamlessly into a corrugated metal roof without any cold bridges. These panels can be tailor-made according to customers' designs and mechanical requirements.

Exceptional light transmission

Lexan ZigZag* sheet systems

Lexan ZigZag sheet systems have been developed to provide an outstanding combination of light transmission and thermal insulation for heated greenhouses. The panels are designed to click easily together, without the need for support profiles. This helps to reduce installation costs and provides glazing that maximizes light transmission while saving on energy costs. The sheet's outer surface is UV-protected and the inner surface is protected with the proprietary Dripgard® coating to help prevent crop spoilage through condensation.

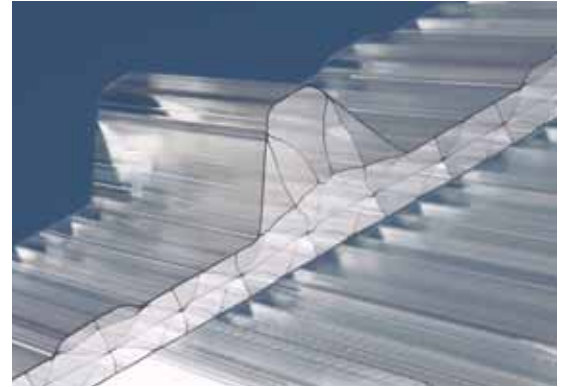

Figure 11

Lexan ZigZag sheet light transmission

Light transmission comparison

Lexan ZigZag sheet	91%
Single layer glass (4mm)	88 - 90%
Acrylic SDP (64mm rib, 2 wall)	86%
Polycarbonate MWS (3 wall)	76%

Figure 12

Insulation value comparison

U-values

Single layer glass (4 mm)	5.8 W / m ² K
Double glass (2*4mm)	2.9 W / m ² K
Acrylic SDP	2.8 W / m ² K
Lexan ZigZag	2.7 W / m ² K

Figure 13

Energy savings versus single layer glass

Energy savings

Momentary	50%
Year round	20 - 45%
	(crop dependent)





Figure 14

Panel weight comparison

Lexan ZigZag panel	4.0 kg/m ²
Single layer glass (4mm)	10.0 kg/m ²
Acrylic SDP (64mm rib distance, 2 wall)	5.0 kg/m ²
Polycarbonate MWS (3 wall)	2.7 kg/m ²



Figure 15
Product Selection Lexan® sheet systems

Structures	Nomenclature	Gauge (mm)	Weight (kg/m)	Rib distance (mm)	U value (W/m² K)	Light transmission Clear (112)	Hobby greenhouses	Professional greenhouses	Swimming pool covers	Verandas	Rooflight	Stadium roofing	Airport / rail / bus terminal roofing	General large building	Industrial roofing and cladding	Furniture / partition walls	Signs
Lexan Thermoclick® sheet 	LTC404X4000	40	4,0	25	1,5	40%							■	■	■	■	
Lexan Thermopanel® sheet 	LTP30A4RS4000	30	4,0	20	1,9	67%					■			■	■		
	LTP30A4RS3600	30	3,6	20	1,9	67%					■			■	■		
	LTP30B4RS4000	30	4,0	20	1,9	67%					■			■	■		
	LTP30C4RS4000	30	4,0	20	1,9	67%					■			■	■		
	LTP30D4RS3600	30	3,6	20	1,9	67%					■			■	■		
	LTP30E4RS4000	30	4,0	20	1,9	67%					■			■	■		
	LTP30E4RS3600	30	3,6	20	1,9	67%					■			■	■		
Lexan Thermoroof® sheet 	LTR65J	65	3,23	35	1,9	55%					■			■	■		
	LTR55K	55	3,30	29	1,9	55%					■			■	■		
Lexan ZigZag® sheet 	LZZ664S	66	4,08	25	2,7	91%	■										

SABIC Innovative Plastics technical support

SABIC Innovative Plastics, Specialty Film and Sheet is a leading supplier of high performance engineering film and sheet products, serving customers around the world in a broad spectrum of industries and applications. The sheet product line includes a wide diversity of structures, ranging from solid sheet, multi-wall sheet and corrugated sheet, through to coated sheet and laminations and combinations of each of these.

Recognized as a center of excellence, the Polymer Processing Development Center in the USA is equipped with state-of-the-art laboratories and facilities for printing, drape forming, thermoforming and prototype testing. Engineers, designers and technologists explore and extend the boundaries of sheet application development through sophisticated material analysis and advanced processing technology.

With satellite development centers in the Netherlands, Japan, China, Korea and India, SABIC Innovative Plastics, Specialty Film and Sheet offers customers around the world access to this full range of laboratory, testing and design services, complemented by local hands-on technical support.

SABIC Innovative Plastics, Specialty Film and Sheet was established in 1968 and now operates a worldwide network of sales, research, manufacturing and technical service facilities. With thirty eight manufacturing sites across the US, Canada, the Netherlands, Italy, Austria, China, and Japan, the company serves customers around the world in a broad spectrum of industries and applications. These include aircraft, appliances, automotive, building and construction, business machines, electrical and lighting, furnishing, greenhouse, industrial roofing, medical, electronics, telecommunications and packaging.

Contact us

Americas

Headquarters

SABIC Innovative Plastics
Specialty Film & Sheet
One Plastics Avenue
Pittsfield, MA 01201
USA
T 800 451 3147
T 413 448 5400
F 413 448 7506

European

Headquarters

SABIC Innovative Plastics
Specialty Film & Sheet
Plasticslaan 1
PO Box 117
4600 AC
Bergen op Zoom
The Netherlands
T +31 164 292911
F +31 164 292940

Pacific

Headquarters

SABIC Innovative Plastics
Specialty Film & Sheet
1266 Nanjing Road (W)
Unit 902-907, Plaza 66
200040 Shanghai
China
T +86 21 3222 4500
F +86 21 6289 8998

Email

sfs.info@sabic-ip.com



THE MATERIALS, PRODUCTS AND SERVICES OF SABIC INNOVATIVE PLASTICS HOLDING BV, ITS SUBSIDIARIES AND AFFILIATES ("SELLER"), ARE SOLD SUBJECT TO SELLER'S STANDARD CONDITIONS OF SALE, WHICH CAN BE FOUND AT <http://www.sabic-ip.com> AND ARE AVAILABLE UPON REQUEST. ALTHOUGH ANY INFORMATION OR RECOMMENDATION CONTAINED HEREIN IS GIVEN IN GOOD FAITH, SELLER MAKES NO WARRANTY OR GUARANTEE, EXPRESS OR IMPLIED, (I) THAT THE RESULTS DESCRIBED HEREIN WILL BE OBTAINED UNDER END-USE CONDITIONS, OR (II) AS TO THE EFFECTIVENESS OR SAFETY OF ANY DESIGN INCORPORATING SELLER'S PRODUCTS, SERVICES OR RECOMMENDATIONS. EXCEPT AS PROVIDED IN SELLER'S STANDARD CONDITIONS OF SALE, SELLER SHALL NOT BE RESPONSIBLE FOR ANY LOSS RESULTING FROM ANY USE OF ITS PRODUCTS OR SERVICES DESCRIBED HEREIN. Each user is responsible for making its own determination as to the suitability of Seller's products, services or recommendations for the user's particular use through appropriate end-use testing and analysis. Nothing in any document or oral statement shall be deemed to alter or waive any provision of Seller's Standard Conditions of Sale or this Disclaimer, unless it is specifically agreed to in a writing signed by Seller. No statement by Seller concerning a possible use of any product, service or design is intended, or should be construed, to grant any license under any patent or other intellectual property right of Seller or as a recommendation for the use of such product, service or design in a manner that infringes any patent or other intellectual property right.

SABIC Innovative Plastics is a trademark of SABIC Holding Europe BV

* Lexan, Solar Control IR, Thermoclear, Thermoclick, Thermopanel, Thermorof and ZigZag are trademarks of SABIC Innovative Plastics IP BV

® Drippgard is a trademark of Standard Bent Glass Corp.

© Copyright 2008 SABIC Innovative Plastics IP BV. All Rights Reserved